

### Step 1 (See Fig 1)

Push two of the **Nylon Inserts (G)** into two of the holes provided that best align with the holes of your signage. A soft-blow hammer may be require to secure the inserts into the holes. Screw the **Eye Hooks (L)** into the **Nylon Inserts (G)**. Hang the **"S" Hook (M)** from the **Eye Hooks (L)** and pinch the ends of the **"S" Hooks (M)** with pliers to secure them.

### Step 2 (See Fig 2)

If rider signage is being used, align and fasten the **Vinyl Rider Clips (E)** on the top side of the arm using the **#8 x 3/4" Painted Screws (J)**.

### Step 3 (See Fig 3)

Insert **Vinyl Arm (B)** through routed holes in the **Vinyl Post (A)**. The recommended arm length is 32" from post, although, slight adjustments may be made to better suit your application. Drive the **#8 x 2" Screw (K)**, through the **Screw Base (H)**, into the punched hole in the post to secure the arm. Snap the **Screw Cap (I)** over the screw head as pictured.

### Step 4 (See Fig 4)

Fasten the **Vinyl End Caps (D)** to the **Vinyl Arm (B)** using pvc glue or all purpose adhesive (not included). Fasten the **Vinyl Gothic Cap (C)** to the top of the **Vinyl Post (A)** using the same method.

### Step 5 ( See Fig 5)

Drive the **Metal Post Stake (F)** into the ground approximately 12". Use a level to ensure the stake is plumb then slide the **Vinyl Post (A)** over the stake.

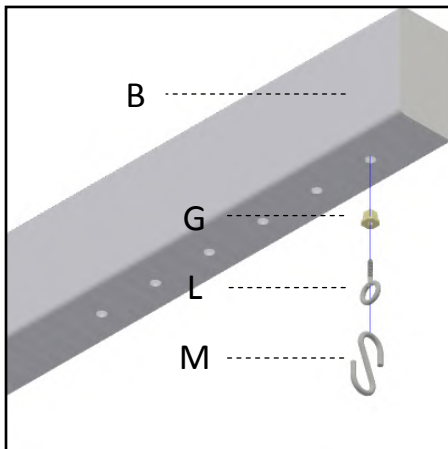

Fig 1

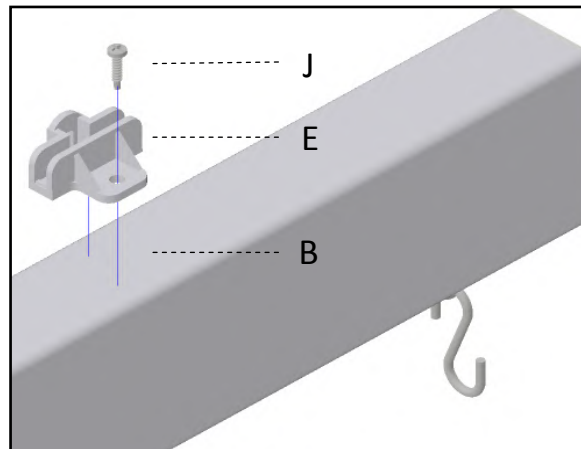

Fig 2

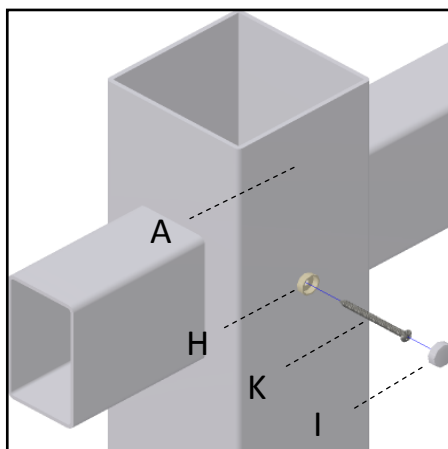

Fig 3

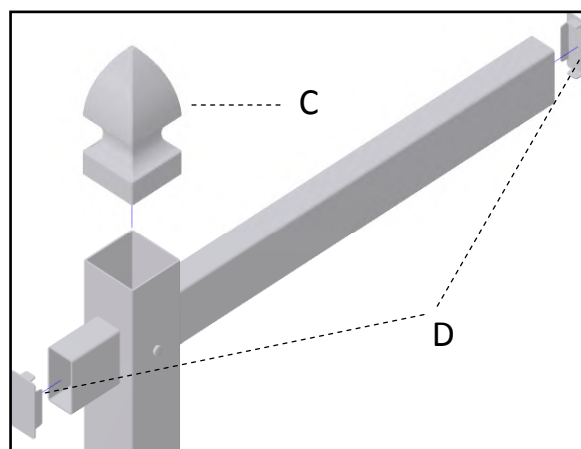

Fig 4

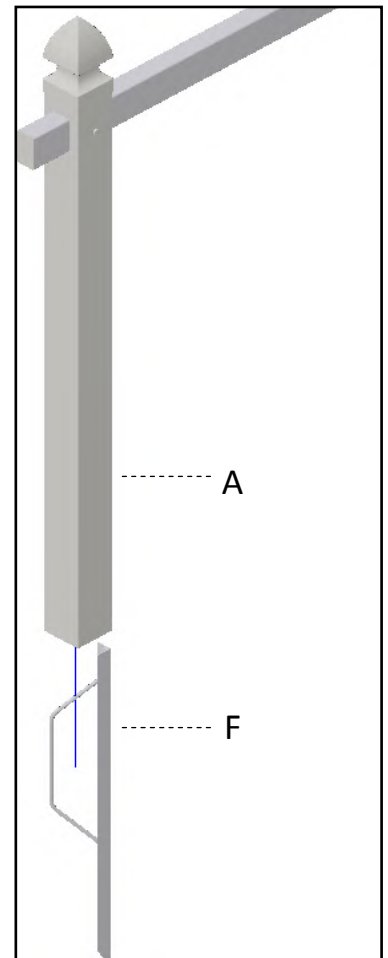















Fig 5

### Material List

Item I.D.	Qty	Description	Illustration
<b>A</b>	1	4" x 4" Vinyl Post	
<b>B</b>	1	2" X 3.5" Vinyl Arm	
<b>C</b>	1	4" Vinyl Gothic Cap	
<b>D</b>	2	2" x 3.5" Vinyl End Cap	
<b>E</b>	2	Vinyl Rider Clip	
<b>F</b>	1	Metal Post Stake	
<b>G</b>	2	Nylon Insert	
<b>H</b>	1	Screw Cap Base	
<b>I</b>	1	Screw Cap	
<b>J</b>	2	#8 x 3/4" Painted Stainless Screw	
<b>K</b>	1	#8 x 2" Stainless Screw	
<b>L</b>	2	Stainless Eye Screw	
<b>M</b>	2	Stainless "S" Hook	

### Required Tools & Material (not included)

Soft Blow Hammer	Pliers	Level w/ Plumb Vial
PVC Glue or All Purpose Adhesive	Tape Measure	Screw Gun or Screw Driver

### Cleaning Recommendations

Wipe with soft rag, all purpose detergent, and warm water. For stubborn stains or blemishes, use cleaner with mild abrasive.